

Thermal & Optical Bi-spectrum Bullet Camera

GLDTB-A4010/640 4MP/1080P dual camera (Optisk 4mm/Therm **10mm**) (vare nr. 22760)

GLDTB-A4025/640 4MP/1080P dual camera (Optisk 8mm/Therm **25mm**) (vare nr. 22761)

GLDTB-A4035/640 4MP/1080P dual camera (Optisk 12mm/Therm **35mm**) (vare nr. 22762)

Ultimate series 640x512 Pixel



GUARDEON

THERMAL CAMERA SERIES

3 LEVELS OF PERFORMANCE. ONE CLEAR CHOICE.

NDA COMPLIANT

MEETS U.S. GOVERNMENT REQUIREMENTS

ULTIMATE SERIES

640 x 512

HIGHEST RESOLUTION. MAXIMUM DETECTION.

PERFORMANCE SERIES

400 x 300

OPTIMAL BALANCE. RELIABLE PERFORMANCE.

ESSENTIAL SERIES

256 x 196

ESSENTIAL PROTECTION. EXCELLENT VALUE.

VISUETT KAMERA 06/05/2026 22:14:37

TERMISK KAMERA 06/05/2026 22:14:37 Termisk temperatur

Features

- ✓ **Thermal & Optical dual** spectrum image, dual video with single IP address, adaptable to more various scenes
- ✓ CMOS 1/2.7" target surface, high sensitivity sensor, satisfy the need of **LUNA** series.
- ✓ Max **4.0MP** 2688x1520@30fps optical
- ✓ Max. **1080P 640x512@30fps** thermal
- ✓ NDAA & NIS2 compliant
- ✓ Thermal support fire detection, smoking detection and fire shield area
- ✓ Thermal module supports temperature detection and cold & hot spot tracking which highlights the abnormal temperature, and links to alarm
- ✓ Thermal & optical dual smart AI edge intrusion prevention: cross line, enter area, leave area, intrusion each camera lens
- ✓ Optical module supports smog recognition, which can help with fire alarm reconfirm
- ✓ Support picture in picture mode, real time contrast live, more convenient and clearer
- ✓ Support audio and light alarm, with red and blue warning lights built in
- ✓ Ultra 265, H.265, H.264, MJPEG
- ✓ **ONVIF**: S, G, T, M
- ✓ API, SDK
- ✓ Alarm: 2 in and 2 out, Audio: 1 in and 1 out
- ✓ MicroSD, up to 512 GB
- ✓ 5 streams
- ✓ 35 simultaneous streams (multi stream)
- ✓ IP67 Weatherproof
- ✓ **Nema 4X** coating for use in harsh environments (offshore, harbor, extreme weather, chemical, food areas)



Specifications

Channel	Optical	Thermal
Camera		
Sensor	1/2.7" CMOS LUNA	Vanadium oxide uncooled focal plane arrays
Max Resolution	4 MP	1080P
Original Resolution	N/A	640 × 512 pixel
Min. Illumination	Color: 0.005 lux (F1.6, AGC ON) B/W: 0.003 lux (F1.6, AGC ON) 0 lux with IR light	N/A
Day/Night	IR-cut filter with auto switch (ICR)	N/A
Original Resolution-Thermal	N/A	640x512 pixel
Pixel Size	N/A	12 μm
NETD	N/A	< 30 mk @ F1.0 @ 25 °C
Shutter	Auto/Manual, 1 to 1/100000 s	
WDR	120 dB	
S/N	>56 dB	
Case Type	Bullet	

Optical Lens	Thermal lens					
	4 mm	8 mm	12 mm	10 mm	25 mm	35mm
Focal Length	4 mm	8 mm	12 mm	10 mm	25 mm	35mm
Iris	F1.6	F1.6	F1.6	F1.0	F1.0	F1.0
Field of View (H)	77.4°	38.3°	24.5°	48.0°	17.4°	12.2°
Field of View (V)	42.2°	21.8°	13.9°	38.3°	14.0°	8.5°
Field of View (D)	95.2°	47.1°	30.1°	59.0°	21.4°	15.0°

DORI Description for Optical

DORI Distance (Detect)	90 m	180 m	270 m	See: DRI Description for Thermal
DORI Distance (Observe)	36 m	72 m	108 m	N/A
DORI Distance (Recognize)	18 m	36 m	54 m	See: DRI Description for Thermal
DORI Distance (Identify)	9 m	18 m	27 m	See: DRI Description for Thermal

WHAT IS DORI & HOW TO USE IT IN CCTV

In the world of CCTV, **DORI** stands for **D**etection, **O**bservation, **R**ecognition and **I**dentification.



DETECTION -

The detection level allows for reliable and easy determination of whether a person or vehicle is present.



OBSERVATION -

The observation level gives characteristic details of an individual, such as distinctive clothing, while allowing a view of activity surrounding an incident.



RECOGNITION -

The recognition level determines with a high degree of certainty whether an individual shown is the same as someone that has been seen before.



IDENTIFICATION -

The identification level enables the identity of an individual beyond a reasonable doubt.

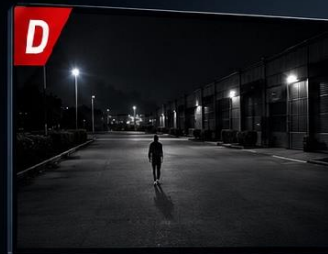

DETECTION

Person detected
Presence confirmed



OBSERVATION

Details visible
Clothing, activity, surroundings



RECOGNITION

Individual recognizable
Can be matched to
a known person



IDENTIFICATION

Identity confirmed
Beyond reasonable doubt

DRI Description for Thermal

Detection, Recognition, and Identification distances are according to Johnson's Criteria.

GUARDEON

DRI WITH THERMAL CAMERA

BASED ON JOHNSONS DRI METHOD



JOHNSONS DRI EXPLAINED

Johnson's DRI is a widely accepted methodology for defining performance levels for thermal imaging systems.

D – DETECTION
The ability to detect the presence of a target (person or object).

R – RECOGNITION
The ability to determine the class of the target.

I – IDENTIFICATION
The ability to identify the target with a high degree of certainty.

D

DETECTION

1.5 pixels / meter



- + Detects the presence of a person or vehicle.
- 📍 No/details, only a heat signature.
- 👁️ Used for wide area surveillance.

R

RECOGNITION

6 pixels / meter



- + Determines the type of object.
- 🚗 Person, vehicle, animal, etc.
- 👁️ Allows assessment of behavior and activity.

I

IDENTIFICATION

12 pixels / meter



- + Identifies the individual with high certainty.
- 👤 Facial features and unique characteristics visible.
- ✔️ Used for evidence and forensic purposes.

EXAMPLE WITH
640 x 512 THERMAL
CAMERA (25mm LENS)

DETECTION DISTANCE (D)

1,800 m

1.5 pixels / meter

RECOGNITION DISTANCE (R)

450 m

6 pixels / meter

IDENTIFICATION DISTANCE (I)

225 m

12 pixels / meter

DRI Range Table Thermal Ultimate series (640x512 pixel)

Thermal Lens	Detection Vehicles: 4.0 × 1.4 m	Detection Humans: 1.8 × 0.5 m	Recognition Vehicles: 4.0 × 1.4 m	Recognition Humans: 1.8 × 0.5 m	Identification Vehicles: 1.4 × 4.0 m	Identification Humans: 1.8 × 0.5 m
10 mm	750 m	370 m	200 m	100 m	130 m	60 m
25 mm	1900 m	950 m	490 m	240 m	330 m	160 m
35 mm	2500 m	1250 m	690 m	340 m	460 m	230 m

Smart Function Table (Thermal) Smart AI

Thermal Lens	SIP Detection Vehicles: 4.0 × 1.4 m	SIP Detection Humans: 1.8 × 0.5 m	Fire Detection target: 0.1x0.1 m	Smoking target: cigarette butt)	Temperature target: 0.1m x 0.1m
10 mm	42 meters	21 meters	9 meters	1 meter	3.5 meters
25 mm	60 meters	30 meters	13 meters	2 meters	8 meters
35 mm	140 meters	70 meters	29 meters	5 meters	20 meters

Illuminator		
Wavelength IR	750 nm	N/A
Illumination Distance (IR)	50 meters - 4 - 8 - 10 mm models 100 meters -12 mm models	N/A
Light On/Off Control	Auto/Manual	N/A
Video		
Frame Rate	4.0 MP (2688 x 1520), Max 30fps	1080P (1920x1080), Max 30fps
Video Compression	Ultra 265, H.265, H.264, MJPEG	
Video Bit Rate	128 Kbps to 16 Mbps	
U-code	Support	
ROI	Support	
Video Stream	5 Streams	
Simultaneous streams	35 Streams	
OSD	Up to 10 OSDs	
Privacy Mask	Up to 8 areas (8 blacks/ 8 mosaics)	N/A
Image		
White Balance	Auto, Outdoor, Fine Tune, Sodium Lamp, Locked, Auto2	N/A
Digital Noise Reduction	2D/3D DNR	
Flip	Normal, Flip Vertical, Flip Horizontal, 180°	
HLC	Support	N/A
BLC	Support	N/A
Defog	Digital Defog	N/A
Palette-Thermal	N/A	white hot, lava, iron oxide red, hot iron, medical, arctic, rainbow 1, rainbow 2, rainbow 3, depict hot, ice hot, black hot, mazarine, fusion, red hot, green hot, color 1, color 2, rain, puce
Low Illumination Characteristics	LUNA	

Intelligent AI edge		
AI Smart Intrusion prevention	Cross line detection, intrusion detection, enter area detection, leave area detection (support false alarm filtering and the classification of human, non-motor vehicle and vehicle)	Cross line detection, intrusion detection, enter area detection, leave area detection (support false alarm filtering and the classification of human and vehicle)
Temperature Range		Selectable between -20 °C to 150 °C
Temperature Detection-Thermal	N/A	Thermal channel supports rule-based temperature measurements. Supports real-time display of the highest, lowest, and average temperatures in the rule defined area on the screen
Smoking Detection-Thermal	N/A	Thermal channel supports the detection of smoking behavior in the environment
Events		
Fire Detection	N/A	Support
Basic Detection	Motion Detection, Tampering Alarm, Audio Detection	N/A
General Function	Watermark, IP Address Filtering, Access Policy, ARP Protection, RTSP Authentication, User Authentication, HTTP Authentication, Alarm Input, Alarm Output	
Audio		
Audio Compression	G.711U, G.711A	
Audio Bitrate	128 Kbps	
Two-way Audio	Support	
Suppression	Support	
Sampling Rate	16KHZ	
Storage		
Edge Storage	MicroSD, up to 512 GB	
Network Storage	ANR	
Network		
Protocols	IGMP, RTP, SMTP, IPv4, IPv6, ICMP, ARP, TCP, UDP, DHCP, PPPoE, RTSP, RTCP, RTMP, DNS, DDNS, NTP, FTP, UPnP, HTTP, HTTPS, 802.1x, SNMP, QoS, SSL/TLS, SSH	
Compatible Integration	ONVIF (Profile S , Profile G , Profile T , Profile M), API, SDK	
User/Host	Up to 32 users. 3 user levels: administrator, common user and operator	
Web. Client & App & software	APP: GuardEye , GuardTool Software: Guardeon VMS lite , Guardeon IP tool & Guardeon Player	
Web Browser	Plug-in required live view: IE 10+, Chrome 45+, Firefox 52+, Edge 79+	

Interface	
Built-in Mic	Support
Built-in Speaker	Support
Audio I/O	2 inputs: impedance 1 kΩ, amplitude 2.5 V [p-p], 1 output: impedance 600 Ω, amplitude 2 V [p-p]
Alarm I/O	3/2
Serial Port	1 x RS485 interface
Network	1 x RJ45 10 M/100 M Base-TX Ethernet
Video Output	N/A 1 BNC (For debugging)
Certification	
EMC	CE-EMC (EN 55032: 2015+A1:2020, EN 61000-3-3: 2013+A1: 2019, EN IEC 61000-3-2: 2019+A1: 2021, EN 50130-4:2011+A1:2014) FCC (FCC CFR 47 part15 B, ANSI C63.4-2014)
Safety	CE LVD (EN IEC 62368-1:2020+A11:2020) UL (UL 62368-1, 2nd Ed., Issue Date: 2014-12-01)
Environment	CE-RoHS (2011/65/EU;(EU)2015/863); WEEE (2012/19/EU); Reach (Regulation (EC) No 1907/2006)
Protection	IP67 (IEC 60529:1989+AMD1:1999+AMD2:2013) NEMA 4X
General	
Power	DC12V (±25%), PoE (IEEE802.3af)
Power Consumption	Max 22,4 watt
Power Interface	Ø5.5 mm coaxial power plug
Dimensions	406 x 130 x 130 mm (L x W x H)
Weight	2,23
Working Environment	-40 °C to 70 °C, Humidity: ≤ 95% RH (non-condensing)
Storage Environment	-40 °C to 70 °C, Humidity: ≤ 95% RH (non-condensing)
Surge Protection	6 KV
Reset Button	Support
RTC	Support
Web Client Language	22 Languages: Traditional Chinese, English, Simplified Chinese, Polish, German, Russian, French, Korean, Dutch, Czech, Portuguese (Europe), Portuguese (Brazil), Japanese, Thai, Turkish, Spanish (Latin America), Spanish (Europe), Hungarian, Italian, Vietnamese, Arabic, Slovak

Live View

Maximum Bitstream	35
Maximum Bandwidth	50 Mbps
Plugin Free	Support
OSD Font	Vector
OSD Color	Support
OSD Character Number	40



Other

Corridor Mode	Support
---------------	---------

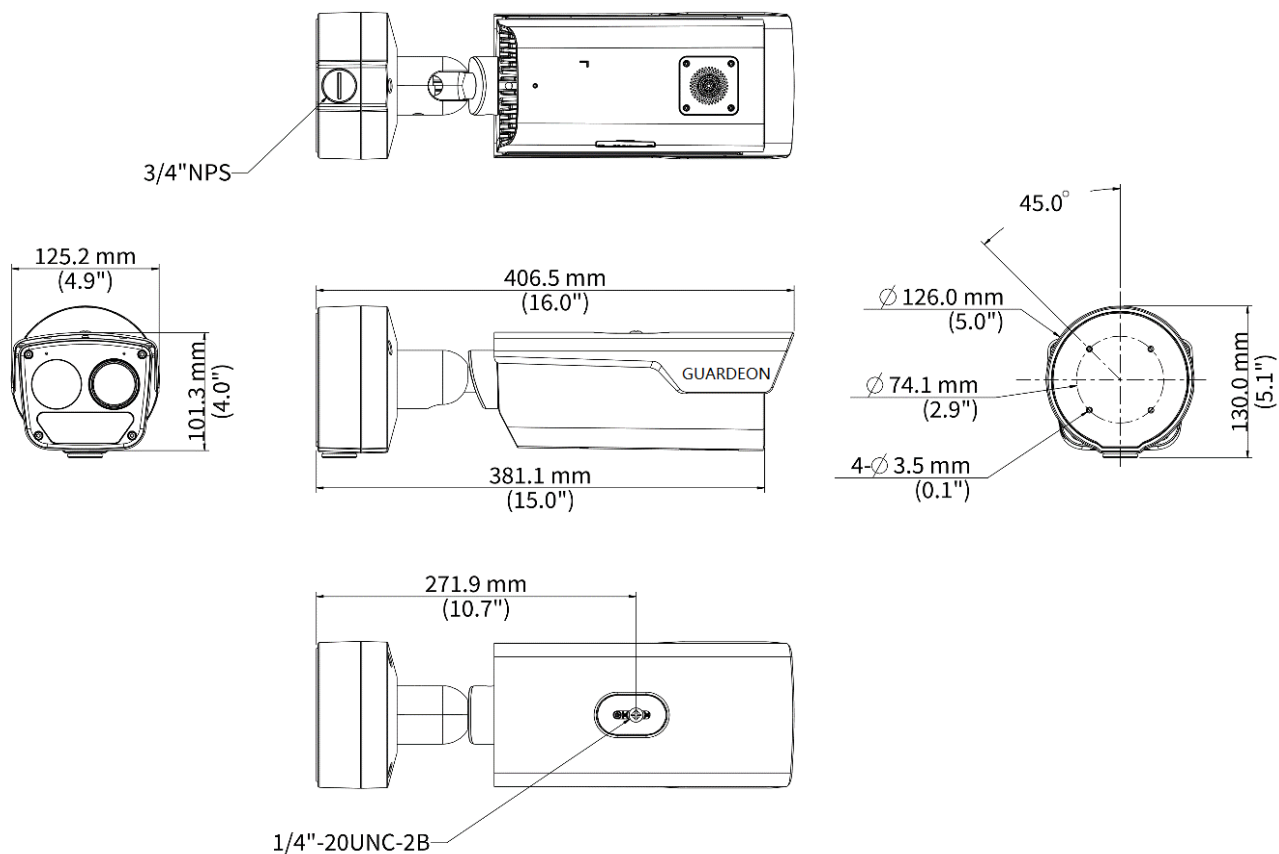
Dimensions



Accessories

GB-137MB polemount	GBD-137HB wall/corner bracket
White alu	White alu
	
Varenr. 22928	Varenr. 22921

* Product specifications and availability are subject to change without notice.

* Despite our best efforts, technical or typographical errors may exist in this document. Gardeon Security Systems cannot be held responsible for any such errors and reserves the right to change the contents of this document without prior notice.

